

Varenummer: 20167B302BL
 Beskrivelse: E+G
 Bred fod holder GN167-B30-2-BL

Mål

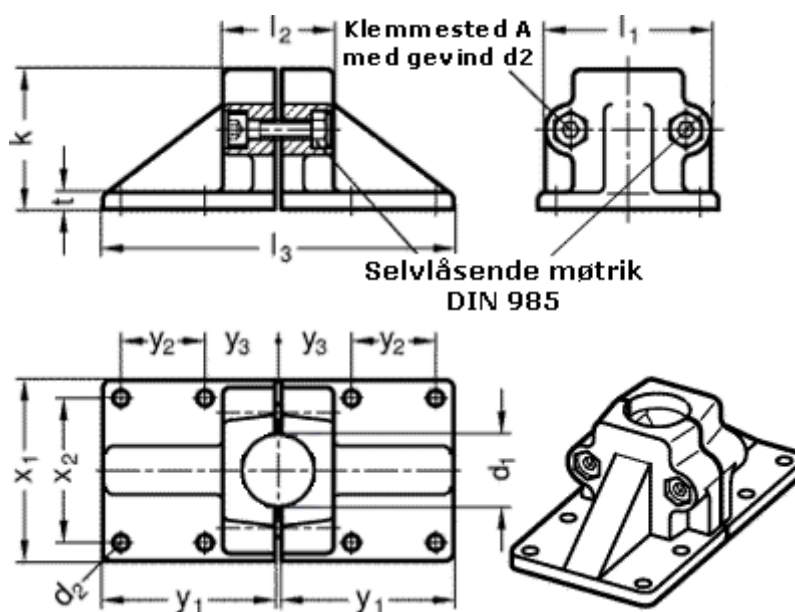

$d_1 = B30$	$x_1 = 75$
$d_2 = 7$	$x_2 = 60$
$d_3 = M 8$	$y_1 = 72$
$k = 58$	$y_2 = 35$
$l_1 = 69$	$y_3 = 30$
$l_2 = 46$	
$l_3 = 146$	
$t = 7$	